

ST9000™ PLASTIC STAPLE® ATTACHER
标签胶钉机

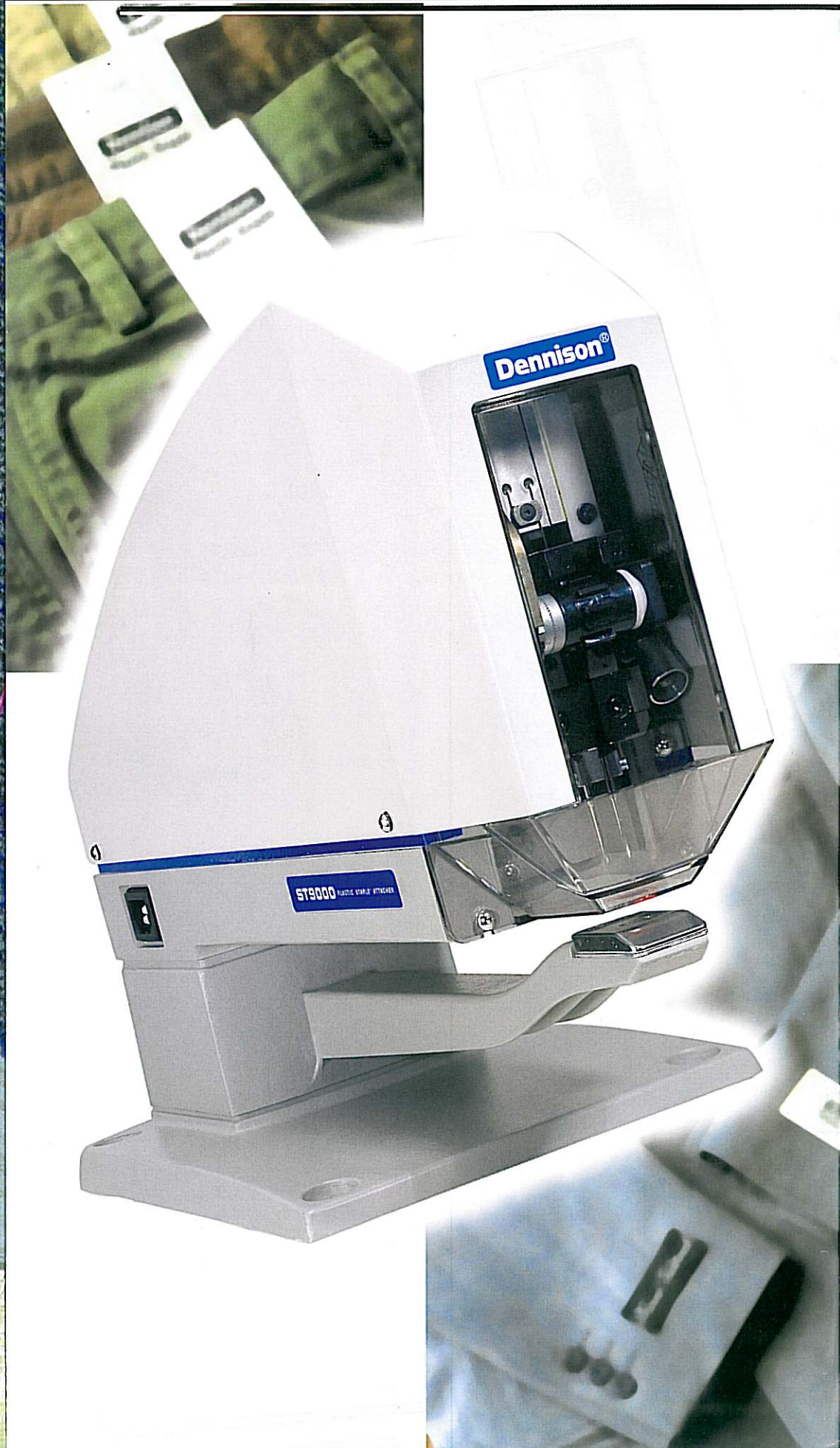

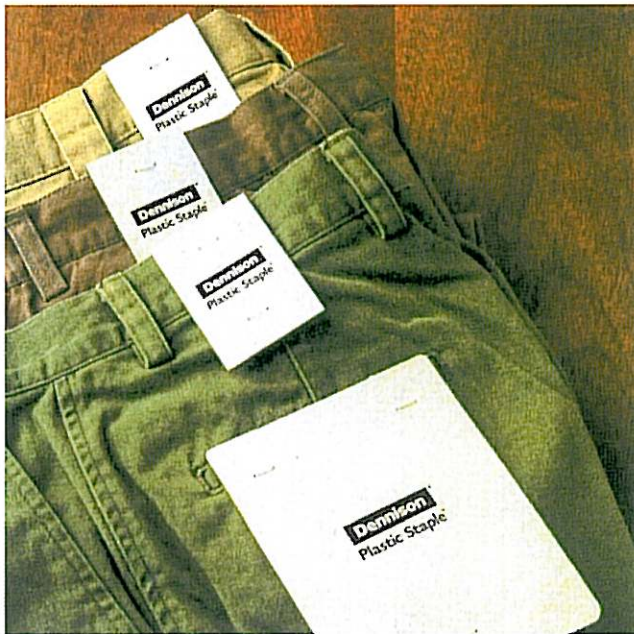

Size/Style tickets and woven tickets are applied to suit/sport coat sleeves using either two (shown) or four PLASTIC STAPLE fasteners. 用两枚或四枚标签胶钉，可把尺码/款式标签和纺织品标签扣在套装或运动服装的衣袖上。



"Pocket flasher" and foldover waistband ticketing operations are combined to increase productivity on casual slacks. 合并袋口标签和折叠型标签的钉装工序，可提高生产便服裤的效率。

The PLASTIC STAPLE™ Fastener.

Easy-to-See Benefits!

- ▶ Manufacturers increase ticketing productivity up to 30%.
- ▶ Consumers enjoy ready-to-wear garments.
- ▶ Apparel Merchandisers improve product presentation at point-of-sale.

Everybody wins, every step of the way!

The flexible polymer design of the PLASTIC STAPLE Fastener insures that the ticket is held securely to the garment, but at home both can easily be removed without damaging the garment.

In fact, consumer research studies show that consumers overwhelmingly prefer PLASTIC STAPLE fasteners for its easy to remove feature*.

PLASTIC STAPLE fasteners give garments a neat, quality look with no loose threads, bent metal staples or sharp pins to detract from the presentation of the garment.

The PLASTIC STAPLE fastener is the only fastener designed specifically for Apparel Manufacturers. Other fastening systems use machines unsuited for high volume apparel ticketing, such as bar tackers, metal staplers, or pinning machines. The result is low productivity, and machine downtime.

The state-of-the-art ST9000™ PLASTIC STAPLE® Attacher is fast, reliable, and ergonomically-correct for apparel ticketing operations.

And with the new ULTRA FINE needles, the PLASTIC STAPLE fastener may be applied to even the most delicate microfiber fabrics.

The PLASTIC STAPLE fastener vs. other fastener options? **Easy Choice. Easy to Apply. Easy to Remove.**

标签胶钉

功能卓越，优点立见

- ▶ 提高标签工序的效率达三成。
- ▶ 衣服可即买即穿，受消费者欢迎。
- ▶ 改善服装店内的货品陈设外观。

快捷妥当，人人受益

标签胶钉以柔软的聚合物材料制成，可保标签牢固地钉在衣物上，顾客购买后亦容易除脱，不损衣服。

消费者调查报告显示，标签胶钉容易除脱，广受消费者欢迎*。

使用标签胶钉，可保持衣物整齐美观，衣物上不再出现松散的缝线、弯曲的金属钉或尖利的针。

标签胶钉是唯一专为成衣制造商设计的钉扣。其他类别的钉扣机多不适合钉装大量成衣标签，如套结机、金属钉装机或钉针机等，全皆效率低，并且经常失灵。

ST9000™ 标签胶钉机新颖精良，快捷妥当，功效宏大，专为钉装成衣标签而设。

只需配以全新的特幼缝针，标签胶钉即可用于纤细的微纤布料上。

标签胶钉，钉装简易，方便除脱，明智消费者之选。不用标签胶钉，不快不易又不妥。

*Wallace & Washburn, Inc., Wellesley MA. Call for copy of full report.

*见 Wallace & Washburn, Inc., Wellesley MA 报告。欲索取报告全文，请致电联络。

Dennison[®]

PLASTIC STAPLE™ Products

A The Dennison ST9000™ PLASTIC STAPLE® Attacher reliably feeds fasteners through dual needles from a continuous reel. The ST9000 is ergonomically designed specifically for fastening items with a safe, secure plastic fastener.

Specifications

Standard Unit Dimensions: 14"H x 19"L x 9"W

Motor: 200/240 Vac, 50/60 Hz. .45/.50 Amp

Unit Weight: 30 lb.

Needle Stroke: 40mm

Needle Diameter: 0.68 Inches, Dual Needles,
Separated 0.375 Inches.

Metric Hardware

B The Vertical ST9000 PLASTIC STAPLE® Attacher inserts fasteners with a vertical orientation.

C PLASTIC STAPLE fasteners are available in reels of 25,000.

D The ST9000 feeds, cuts and inserts one Plastic Staple fastener at a time.

E Made of resilient polyurethane, the fastener stretches slightly during insertion to securely hold items of varying thicknesses.

F Each ST9000 comes with an easy to follow Operator and Service Manual. A Service tape is also available.

G An ergonomically designed Foot Pedal is available to actuate the ST9000.

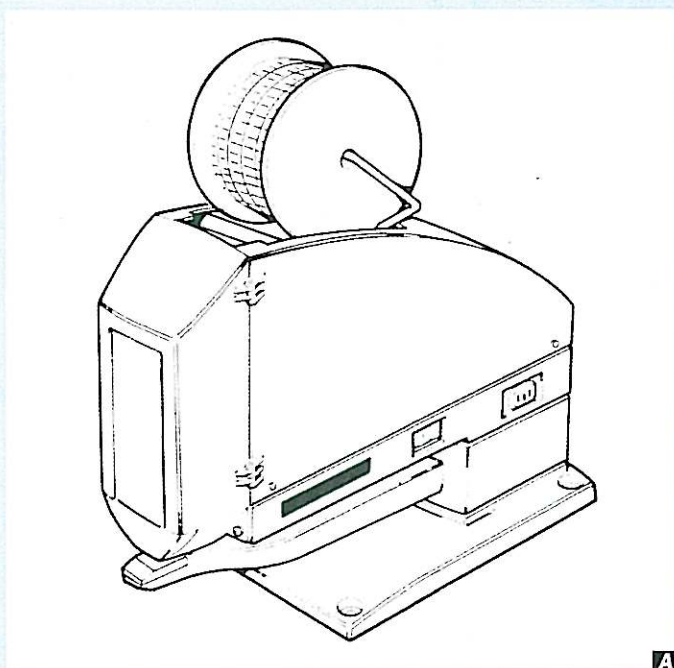

A

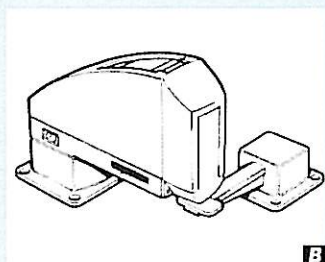

B

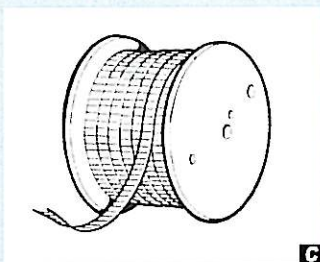

C

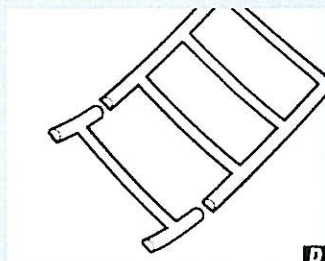

D

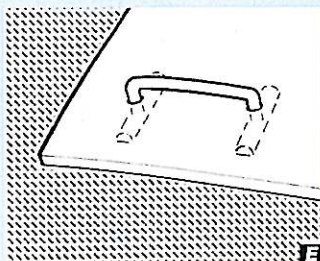

E

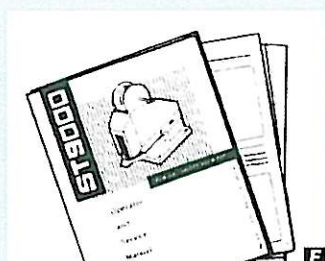

F

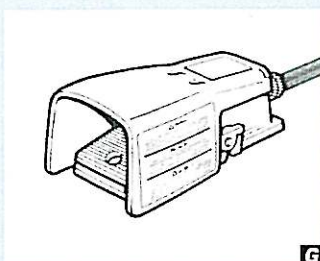

G

标签胶钉产品系列

A Dennison的ST9000™ 标签胶钉机设有双针，可把卷轴上的胶钉牢固地钉在衣物上。

说明

标签胶钉机标准尺码：高14寸x长19寸x宽9寸

马达：200/240交流电压；50/60赫；.45/.50安培

标签胶钉机重量：30磅

针刺行程：40毫米

针直径：0.68寸，双针相距0.375寸。

公制硬件

B 直立式ST9000标签胶钉机可把胶钉垂直钉在衣物上

C 每卷标签胶钉共有25,000枚胶钉。

D ST9000标签胶钉机每次可把一枚胶钉钉在衣物上。

E 标签胶钉用富弹性的聚胺酯制成，具伸缩性，确保标签胶钉紧扣在厚薄不同的衣料上。

F 每部ST9000标签胶钉机均附有简易说明书，详细讲解机件的操作及性能(备有示范录影带)。

G 备有脚踏设计，方便启动。

香港代理：

東成針車行有限公司 (總公司)
香港九龍深水埗南昌街 61-65號東成大廈地下
Hong Kong Agent(Main Office):
Tung Shing Sewing Machine Company Limited
61-65 Nam Cheong Street, G/F., Tung Shing Bldg.,
Shamshuipo, Kowloon, Hong Kong
Tel:(852)2725 4633 Fax:(852)2785 5375
Website: <http://www.tungshing.com.hk>
E-mail: info@tungshing.com.hk

越南總代理：

越進東成公司 (總公司)
胡志明市第五郡陳興道街719號
Vietnam Sole Agent (Main Office):
Viet Tien Tung Shing Corporation
719 Tran Hung Dao St., Dist. 5,
Hochiminh City, Vietnam
Tel:84-8-8380330 Fax:84-8-8380328
Website: <http://www.tsg.com.vn>
E-mail: vts@tsg.com.vn

中國代理：

東成針車行有限公司
廣州市十八甫路18號
China Agent (Main Office):
Tung Shing Sewing Machine Firm
18, Shi Ba Fu Road, Guang Zhou, China
Tel:(8620)81889690 Fax:(8620)81840889